

外視 / External view

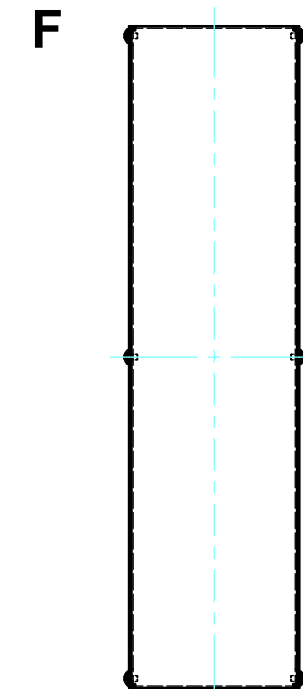

構成内容 / Components				
No.	名称 / Part name	数量 / Pcs	材質 / Material	色・表面処理 / Color・Finish
1	カバー Cover	1	アルミ板 A1100P t1.0 Aluminium A1100P t1.0	表面 メタリックシルバー塗装, 裏面 導通処理 Metallic silver painted, Inside Conductivefinished
2	シャーシ Base	1	アルミ板 A1100P t1.0 Aluminium A1100P t1.0	表面 メタリックシルバー塗装, 裏面 導通処理 Metallic silver painted, Inside Conductivefinished
3	取付ビス(トラスM3 x 5) Screw(Truss head M3 - 5)	6	真ちゆう Brass	ニッケルメッキ Nickel Plated
4	ワッシャー(M3用) Washer(M3)	6	真ちゆう Brass	ニッケルメッキ Nickel Plated

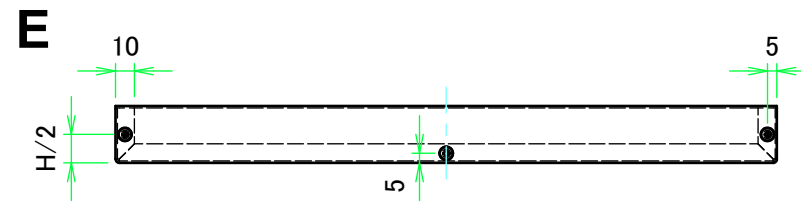
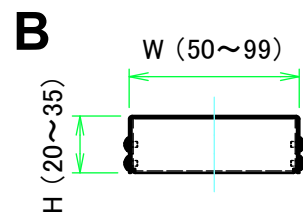
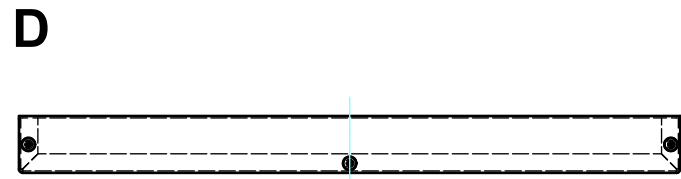
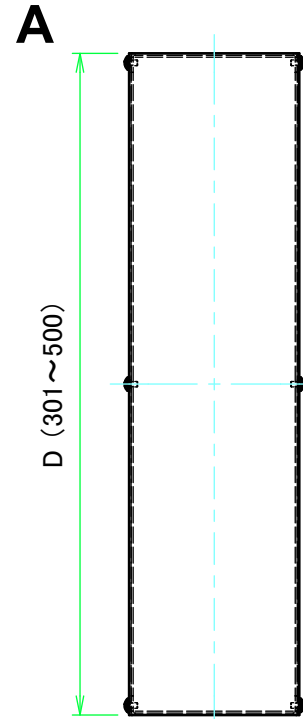
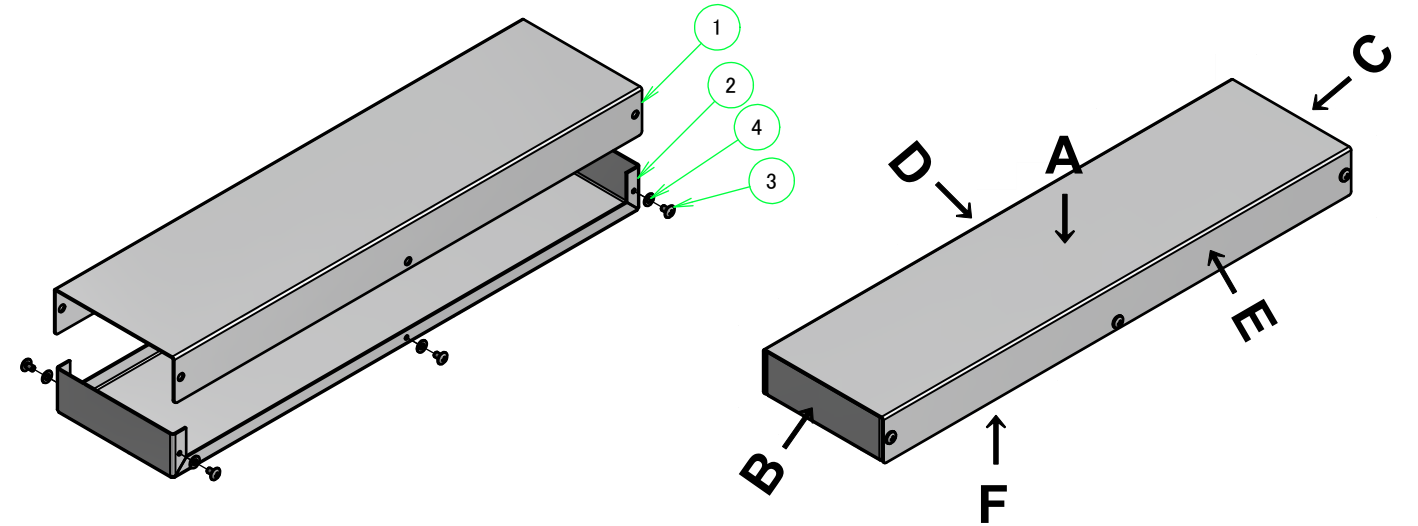

ケース型番 / Product Number

MBF  -  -  A 10  
W H D シャーシタイプ・板厚(補強なし・t1.0)  
 Base type・thickness(standard・t1.0)

W・H・D 寸法制限範囲 / Dimension limit range		
W	H	D
50~99	20~35	301~500

\* ケース寸法範囲内でも対応できない場合があります。詳細はカタログ内価格表でご確認ください。  
 \* Size combinations available will vary based on each base type. For more information, refer to our catalog, or inquire.

株式会社タカチ電機工業 TAKACHI ELECTRONICS ENCLOSURE CO., LTD.		品名/Title アルミフリーサイズケース CUSTOM DIMENSIONS CASE	尺度/Scale
承認/Approved	検図/Checked	製図/Created	
中根	大江	横田	作成日/Date 2019/06/20
			1 / 3

カバー / Cover

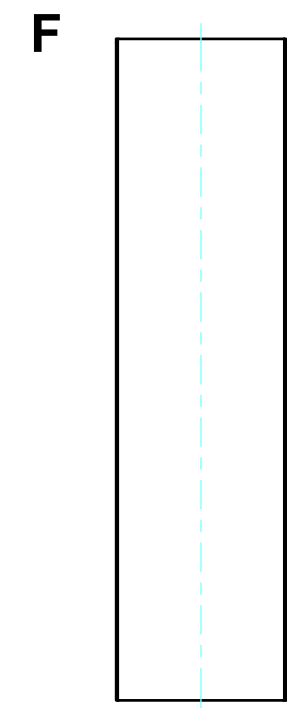
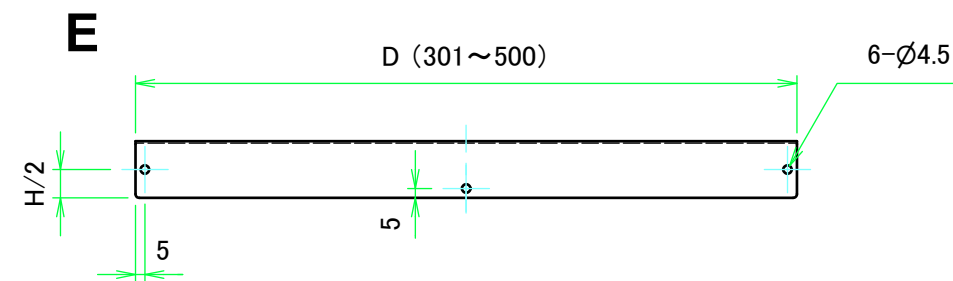
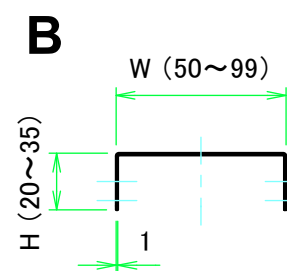
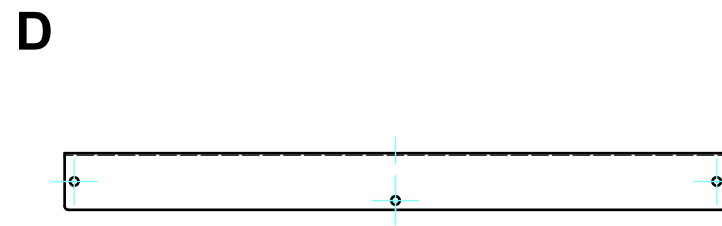
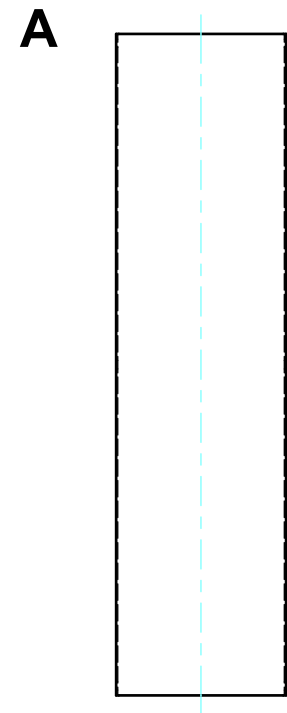

株式会社タカチ電機工業 TAKACHI ELECTRONICS ENCLOSURE CO., LTD.			品名/Title アルミフリーサイズケース CUSTOM DIMENSIONS CASE	尺度/Scale 1:4
承認/Approved	検図/Checked	製図/Created	型番/Product number MBF□-□-□ A10 (D ≥ 301)	
中根	大江	横田	作成日/Date 2019/06/20	2 / 3

シャーシ / Base

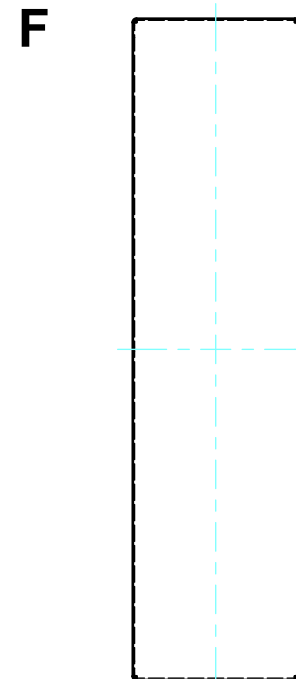
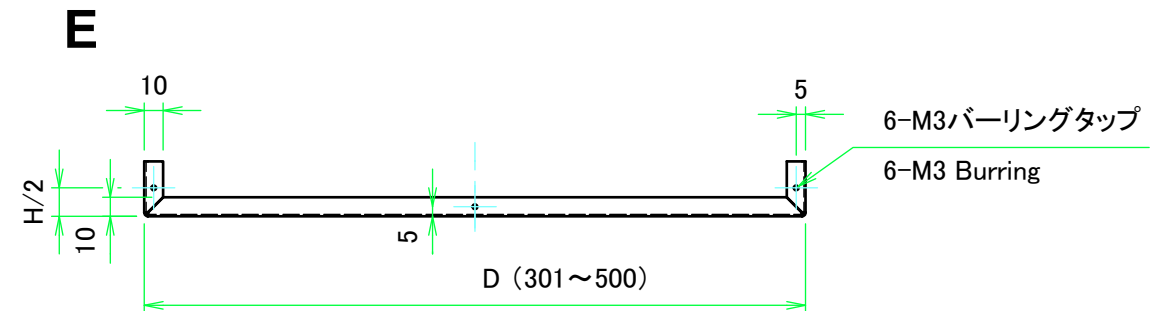
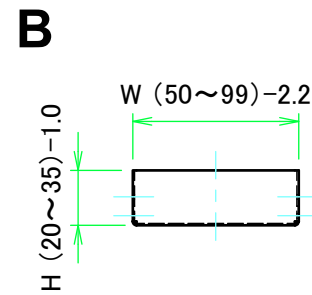
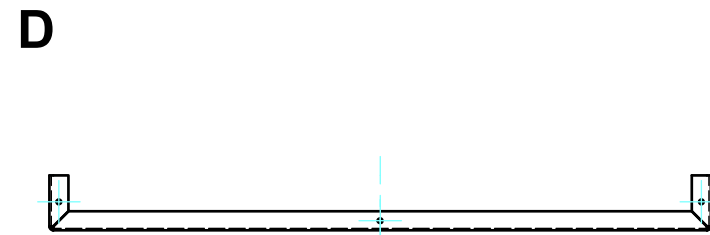
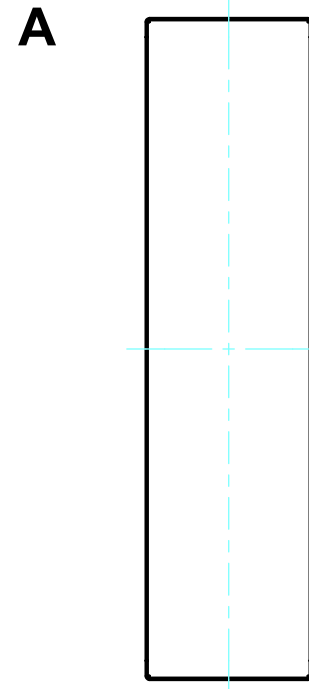

株式会社タカチ電機工業 TAKACHI ELECTRONICS ENCLOSURE CO., LTD.			品名/Title アルミフリーサイズケース CUSTOM DIMENSIONS CASE	尺度/Scale 1:4
承認/Approved	検図/Checked	製図/Created	型番/Product number MBF□-□-□ A10 (D ≥ 301)	
中根	大江	横田	作成日/Date 2019/06/20	3 / 3